



# User Guide

300Mbps Wi-Fi Range Extender  
TL-WA855RE

# Contents

About This Guide .....	1
<b>Chapter 1. Get to Know About Your Extender .....</b>	<b>3</b>
1. 1. Product Overview.....	4
1. 2. Appearance .....	4
1. 2. 1.LED Explanation.....	5
1. 2. 2.Port and Button Description.....	5
<b>Chapter 2. Set Up Internet Connection .....</b>	<b>6</b>
2. 1. Power On the Extender .....	7
2. 2. Set Up the Extender .....	7
2. 2. 1.Method 1: Via the TP-Link Tether App.....	7
2. 2. 2.Method 2: Via the WPS Button.....	9
2. 2. 3.Method 3: Via a Web Browser .....	10
<b>Chapter 3. Customize Your Network.....</b>	<b>14</b>
3. 1. Check Internet Status.....	15
3. 2. Configure Wireless Network .....	16
3. 3. Change LAN Settings.....	17
3. 4. Adjust Wi-Fi Coverage .....	18
3. 5. Set Access Control .....	19
<b>Chapter 4. More Features of Your Extender.....</b>	<b>23</b>
4. 1. Use Your Extender as a Wireless Adapter.....	24
4. 2. Transform Your Existing Wired Network to a Wireless One .....	24
<b>Chapter 5. Manage Your Extender .....</b>	<b>26</b>
5. 1. Set Up System Time .....	27
5. 1. 1.To get system time:.....	27
5. 1. 2.To set up Daylight Saving Time:.....	28
5. 2. Control LEDs .....	28
5. 3. Power Schedule .....	29
5. 4. Upgrade the Firmware .....	30
5. 5. Backup and Restore Configuration Settings.....	31
5. 6. Reboot Your Extender.....	32
5. 7. Change Login Password .....	33
5. 8. System Log.....	34
<b>FAQ .....</b>	<b>35</b>



# About This Guide

This guide is a complement to Quick Installation Guide. The Quick Installation Guide provides instructions for quick internet setup, while this guide contains details of each function and demonstrates how to configure them.

Features available in the extender may vary by model and software version. Extender availability may also vary by region or ISP. All images, steps, and descriptions in this guide are only examples and may not reflect your actual extender experience.

## Conventions

In this guide the following conventions are used:

Convention	Description
<u>Underlined</u>	Underlined words or phrases are hyperlinks and You can click to redirect to a website or a specific section.
Teal	Contents to be emphasized and texts on the web page are in teal, including the menus, items, buttons, and so on.
>	The menu structures to show the path to load the corresponding page. For example, <a href="#">Advanced</a> > <a href="#">Wireless</a> > <a href="#">MAC Filtering</a> means the MAC Filtering function page is under the Wireless menu that is located in the Advanced tab.
<b>Note:</b>	Ignoring this type of note might result in a malfunction or damage to the device.
<b>Tips:</b>	Indicates important information that helps you make better use of your device.
symbols on the web page	<ul style="list-style-type: none"><li> click to edit the corresponding entry.</li><li> click to delete the corresponding entry.</li></ul>

\*Maximum wireless signal rates are the physical rates derived from IEEE Standard 802.11 specifications. Actual wireless data throughput and wireless coverage per ft<sup>2</sup> are not guaranteed and will vary as a result of 1) environmental factors, including building materials, physical objects, and obstacles, 2) network conditions, including local interference, volume and density of traffic, product location, network complexity, and network overhead, and 3) client limitations, including rated performance, location, connection quality, and client condition.

## More Info

The latest software, management app and utility are available from the [Download Center](#) at [www.tp-link.com/support](http://www.tp-link.com/support).

The Quick Installation Guide can be found where you find this guide or inside the package of the range extender.

Specifications can be found on the product page at <http://www.tp-link.com>.

TP-Link Community is provided for you to discuss our products and share knowledge at <https://community.tp-link.com>.

Our Technical Support contact information can be found at Contact Technical Support page at [www.tp-link.com/support](http://www.tp-link.com/support).

## Chapter 1

---

# Get to Know About Your Extender

---

This chapter introduces what the extender can do and its appearance.

It contains the following sections:

- [Product Overview](#)
- [Appearance](#)

## 1.1. Product Overview

### Bring Dead Zones Back to Life

Tired of Wi-Fi “dead zones”? The TP-Link extender is connected to your router wirelessly, strengthening its signal and expanding its coverage into areas that could not otherwise be reached. The device also reduces signal interference to ensure reliable Wi-Fi coverage throughout your home or office.

### Easy Installation & Quick Position

The extender works with any standard wireless router. Instantly connect the extender to a router by pressing the router’s WPS button (if available) followed by the extender’s WPS button. Alternatively, follow the Quick Setup instructions on the extender’s web management page.

Once the extender is connected to a router, you can relocate it to your preferred location with no further configuration required. The intelligent signal light can help to find the best location.

### Easy Management with the Tether APP

Tether provides a simple, intuitive way to access and manage your extender with your smart devices.

## 1.2. Appearance



■ **Note:** The provided plug may differ from the picture due to different regional power specifications. The European version is used for demonstration in this User Guide.

### 1.2.1. LED Explanation

You can check the extender's working status by following the LED Explanation table.

Name	Status	Indication
Signal	Solid blue	The extender is connected to your router's wireless network and is in a suitable location.
	Solid red	The extender is experiencing poor signal strength. Try relocating it closer to your router.
	Blinking	WPS connection is in progress.
	Off	No wireless connection is established.
Power	On/Off	The extender is on or off.
	Blinking	The system is starting up or firmware upgrade is progress.

### 1.2.2. Port and Button Description

Ports or Buttons	Description
(WPS Button)	Press the WPS button on your host router, and immediately press the WPS button on the extender for 1 second. The Signal LED of the extender should change from blinking to solid on, indicating successful WPS connection.
RESET Button	With the extender powered on, use a pin to press the RESET button for 1 second. The extender will reset and reboot.
Ethernet Port	Connect your Ethernet-only device to the Ethernet port of the extender to join the network.

■ **Note:** Make sure the device is being used within 0-40°C and stored within -40-70°C.

## Chapter 2

---

# Set Up Internet Connection

---

This chapter informs you how to boost your host wireless coverage. Please follow the step-by-step instructions to set up the internet connection.

It contains the following sections:

- [Power On the Extender](#)
- [Position Your Extender](#)



## 2.1. Power On the Extender

Plug the extender into an electrical outlet **near your host router**, and then wait until the Power LED turns solid on.

■ **Note:** For safety, we suggest that you plug the extender in upright directions as shown below.

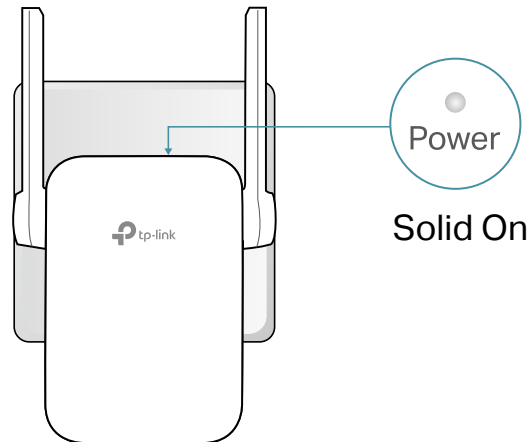

## 2.2. Set Up the Extender

There are three ways to connect to the host network: via the WPS button, via a web browser, or via the Tether app.

### 2.2.1. Method 1: Via the TP-Link Tether App

1. Launch the Apple App Store or Google Play Store and search **TP-Link Tether** or simply scan the QR code to download and install the app.



2. Launch the Tether app and log in with your TP-Link ID.

■ **Note:** If you don't have a TP-Link ID, create one first.

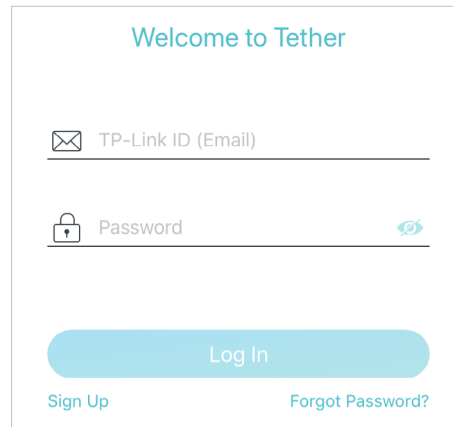

3. Tap the + icon on the upper-right corner and select **Range Extender**.

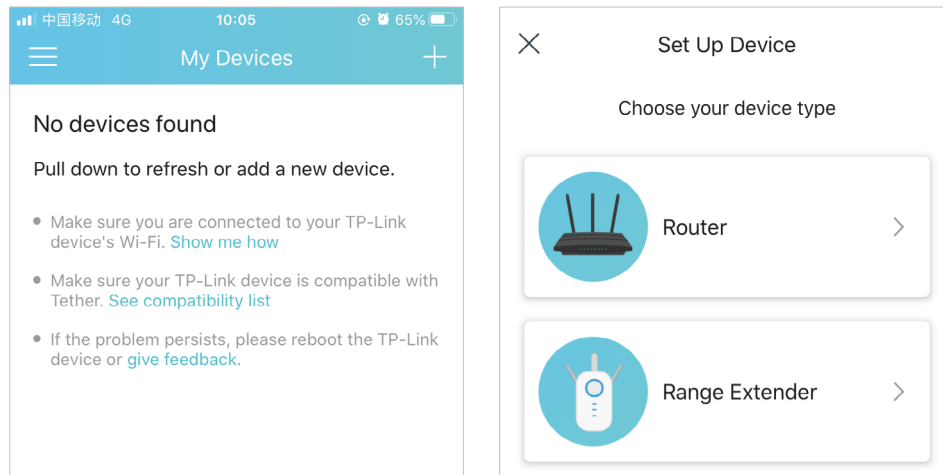

4. Follow app instructions to set up your extender.

5. Relocate your extender to optimize Wi-Fi coverage and performance.

- 1) Plug in the extender about halfway between your router and the Wi-Fi dead zone. The location you choose must be within the range of the host network.
- 2) Wait for about 2 minutes until the Signal LED turns solid blue. If not, relocate the extender closer to the router to achieve better signal quality.

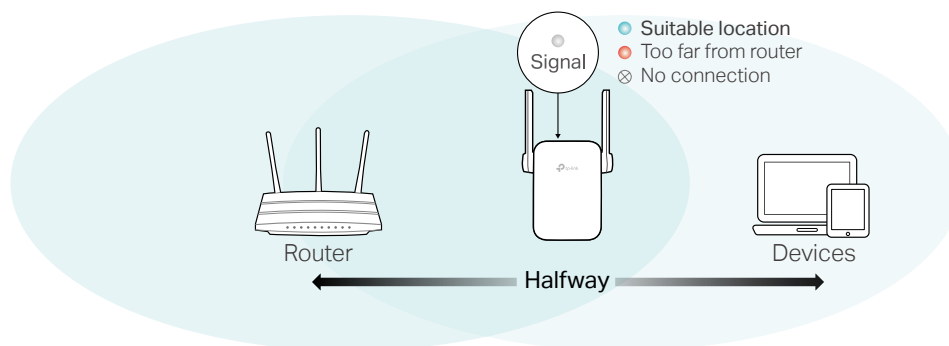

6. **Enjoy!** Connect to the extended network and enjoy internet.

### Tips:

For more intuitive location assistance, access extender settings via Tether and go to Tools > Location Assistant. You can also manage your extender via Tether, such as controlling LEDs, sharing passwords of your networks and blocking devices.

## 2.2.2. Method 2: Via the WPS Button

Use this way if your router has a WPS button. The button might look like one of these:



1. Press the WPS button on your host router, and then press the WPS button on the extender for 1 second within 2 minutes.



### Note:

For more information about using WPS button on your host router, please refer to the router's user guide.

2. Wait until the Signal LED changes from blinking to solid on, indicating successful connection.

### Note:

If the LED does not turn solid on, try again or refer to [Method 1: Via the TP-Link Tether App](#) or [Method 3: Via a Web Browser](#).

3. The extender uses your router's network name with `_EXT` at the end and shares the same password as your router.



### **Extended Network Name:**

Router's network name with `_EXT` at the end

### **Password:**

Same as your router's

### Note:

If you want to customize the extended network name, refer to [Configure Wireless Network](#).

4. Relocate your extender for optimal Wi-Fi coverage and performance.
  - 3) Plug in the extender about halfway between your router and the Wi-Fi dead zone. The location you choose must be within the range of the host network.
  - 4) Wait for about 2 minutes until the Signal LED turns solid blue. If not, relocate the extender closer to the router to achieve better signal quality.

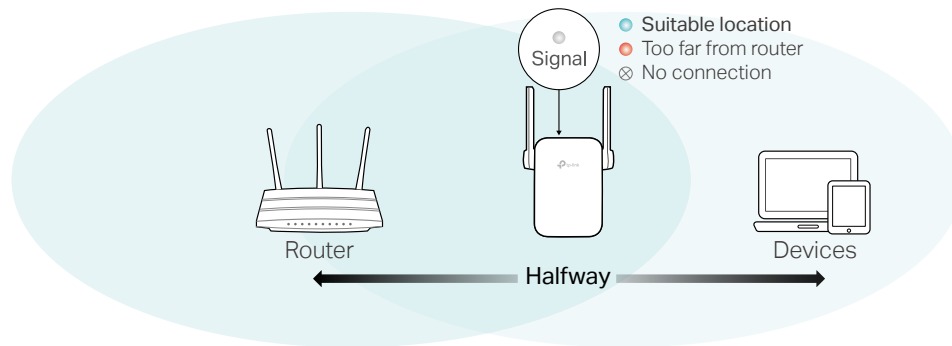

**Tips:**

To minimize signal interference, please choose a location which is far away from Bluetooth devices and other household electronic devices, such as cordless phones, microwave ovens and baby monitors.

5. **Enjoy!** Connect to the extended network and enjoy internet.

### 2.2.3. Method 3: Via a Web Browser

1. Connect your computer to the extender via an Ethernet cable, or connect wirelessly as follows:

- For Windows Users

5) Unplug the Ethernet cable from your computer (if any).

6) Click the Wi-Fi icon on the task bar and connect to the extender's network: [TP-Link\\_Extender](#).

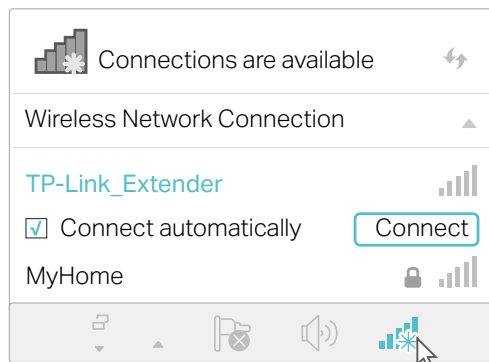

- For Mac OS X Users

1) Unplug the Ethernet cable from your computer (if any).

2) Click the Wi-Fi icon in the top right corner of the screen, and connect to the extender's network: [TP-Link\\_Extender](#).

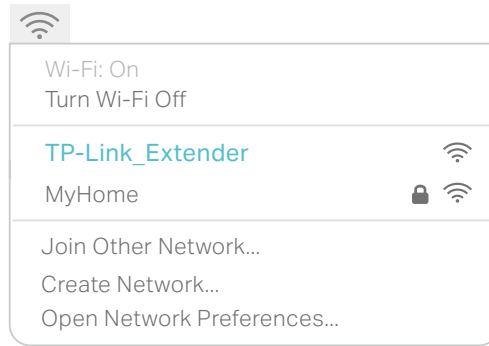

2. Follow the instructions of Quick Setup Wizard to connect the extender to your host router.

- 1) Launch a web browser, enter <http://tplinkrepeater.net> or <http://192.168.0.254> in the address field, create a password for future logins, and click **LOG IN**.

**Create Login Password**

New Password:

Please enter 1-15 characters using a combination of numbers and symbols.

Confirm Password:

**LOG IN**

■ **Note:**

If the login window does not appear, please refer to [FAQ](#).

- 2) Select your host router's 2.4GHz SSID (network name), enter its password (NOT the password you just created for logins), and click **NEXT**.

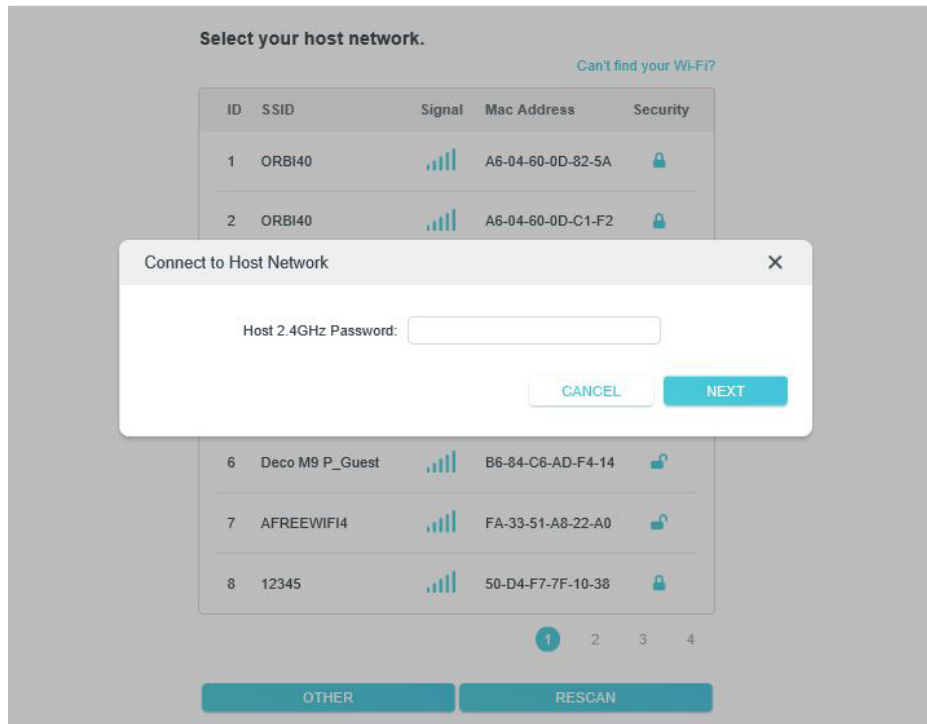

- 3) Confirm the password of your 2.4GHz host network to make sure your extended network have internet access. If the password is right, click [CONFIRM](#).

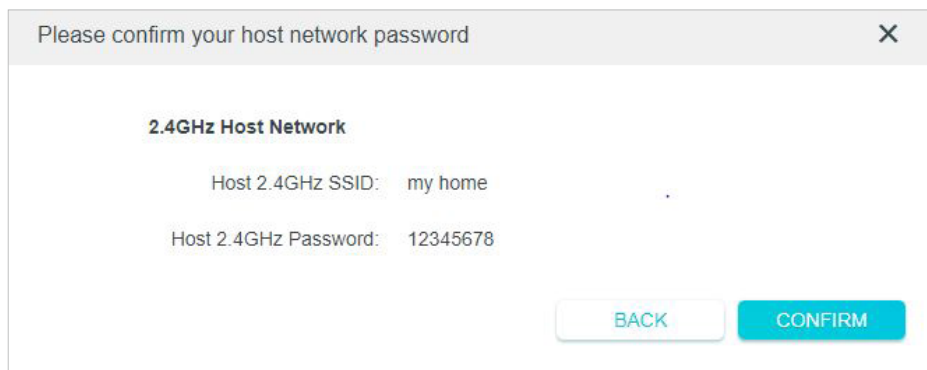

- 4) Either keep the default SSID (network name) or customize it for the extended network, and then click [NEXT](#).

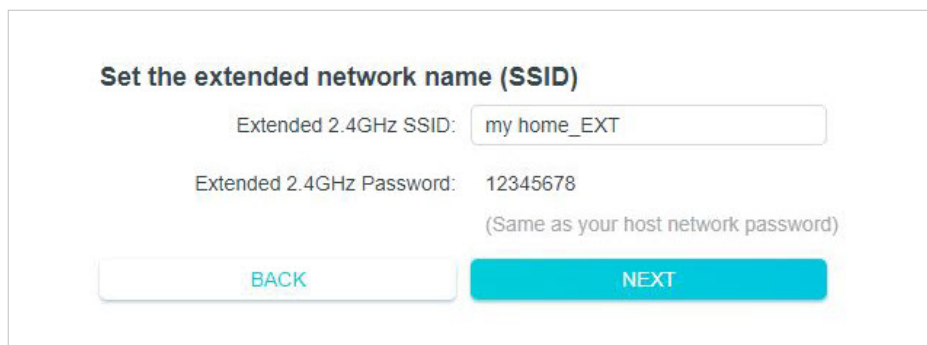

- 5) Follow web instructions to relocate your extender for optimal Wi-Fi coverage and performance, then click **DONE**.

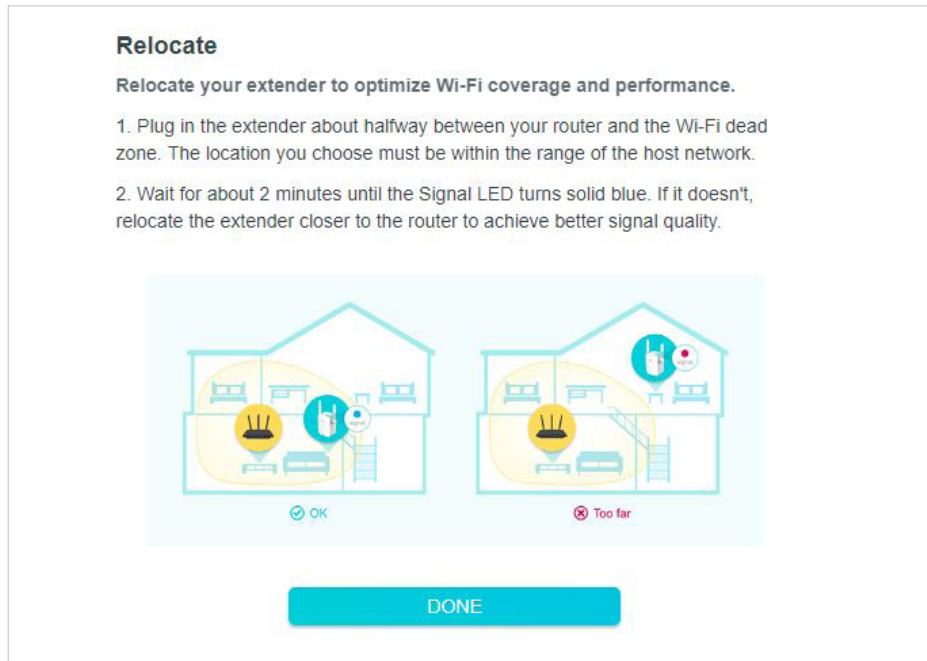

- 6) **Enjoy!** Connect to the extended network and click **FINISH** to enjoy internet.

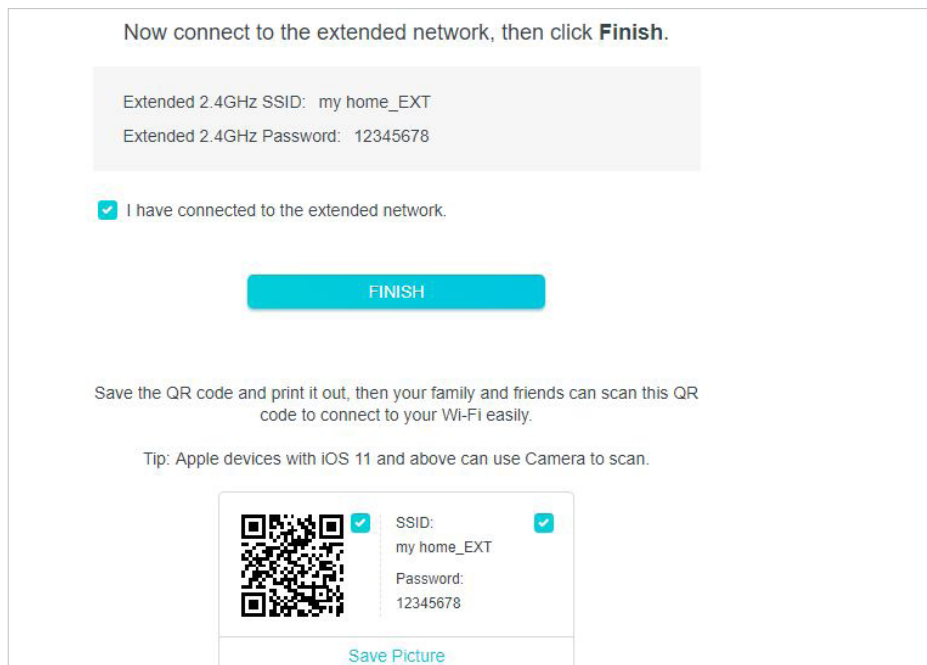

## Chapter 3

---

# Customize Your Network

---

This chapter guides you on how to configure network settings that are available for this extender.

It contains the following sections:

- [Check Internet Status](#)
- [Configure Wireless Network](#)
- [Change LAN Settings](#)
- [Adjust Wi-Fi Coverage](#)
- [Set Access Control](#)



## 3.1. Check Internet Status

You can view the internet status of your extender to check whether you have successfully set up the extended network(s).

1. Visit <http://tplinkrepeater.net>, and log in with the password you set for the extender.
  2. Go to [Network Map](#) to view the internet status of your extender.
- The extender is functioning normally.

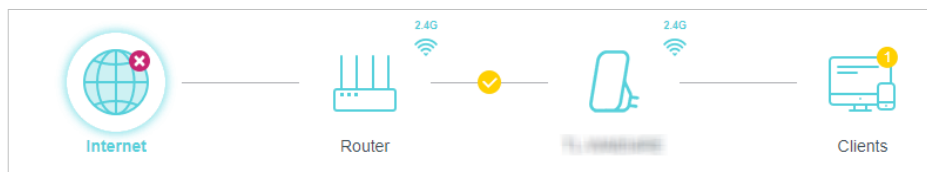

- The extender is not connected to the host network. Please go to [Wireless](#) to check whether the host network passwords are correct. If the problem still exists, relocate the extender closer to the router to achieve better signal quality.

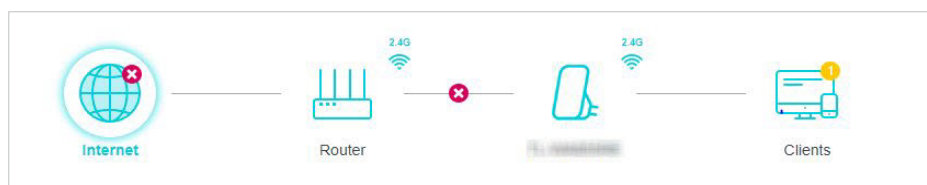

- The extender is connected to the host network, but is not transmitting data. Please check your router's internet connection.

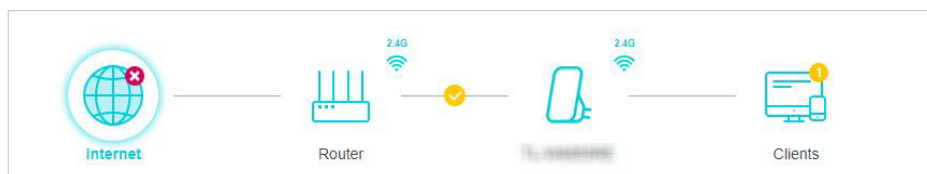

- The extender is connected to the router abnormally. Please go to [Settings](#) > [Network](#) and try setting your extender to obtain an IP address automatically.

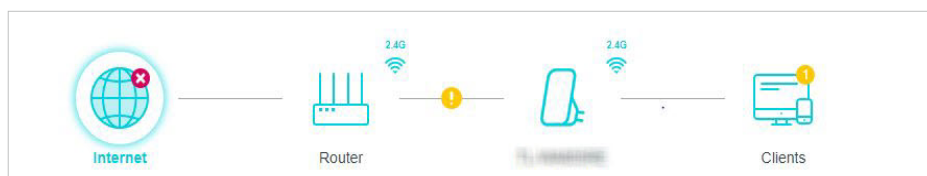

Click the Internet/Router/Range Extender/Clients icon to view the corresponding information.

## 3.2. Configure Wireless Network

If you want to extend another host network after Quick Setup, you can refer to this section. Moreover, you can change the wireless settings for your extended network.

Visit <http://tplinkrepeater.net>, and log in with the password you set for the extender.

- **To extend another host network:**

1. Go to [Wireless](#) and locate the [Connect to Host Network](#) section.

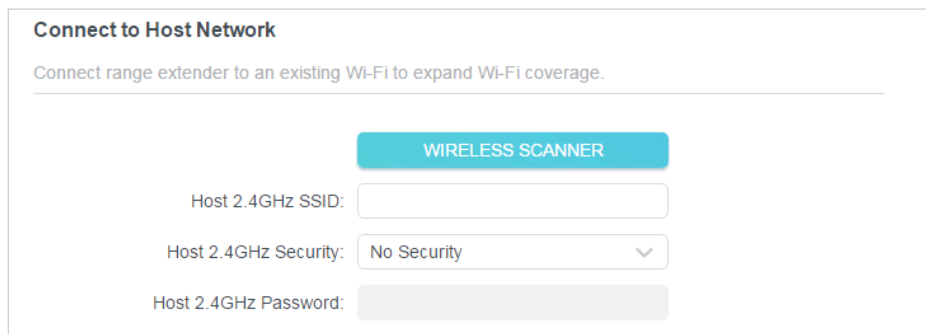

**Connect to Host Network**  
Connect range extender to an existing Wi-Fi to expand Wi-Fi coverage.

[WIRELESS SCANNER](#)

Host 2.4GHz SSID:

Host 2.4GHz Security:

Host 2.4GHz Password:

2. Click [WIRELESS SCANNER](#) to find all available networks.

3. Select the host network you want to extend.

■ **Note:**

If the network you want to extend is on but not listed, please try the following steps.

1. Move the extender closer to your router, and click [Refresh](#) in the top-right corner of the list.
  2. You can manually enter the parameters of the network you want to extend, and click [SAVE](#).
4. Once a host network is selected, the SSID and security type will be automatically filled in. If the selected network is encrypted, enter the password in the [Password](#) field.
  5. Click [SAVE](#).

- **To change the wireless network name (SSID):**

1. Go to [Wireless](#) and locate the [Extended Network](#) section.

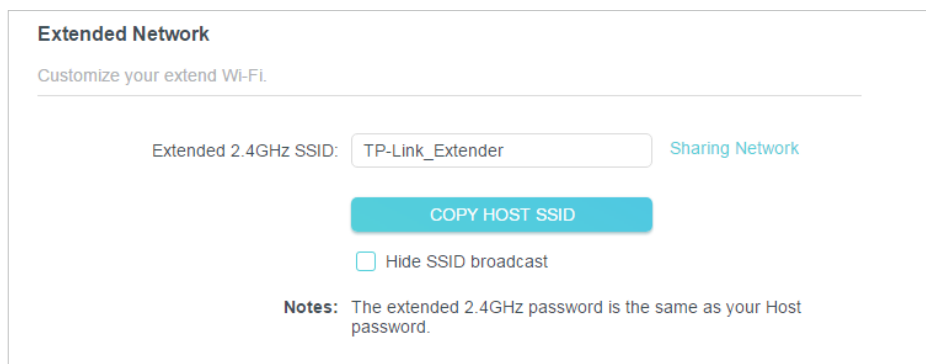

**Extended Network**  
Customize your extend Wi-Fi.

Extended 2.4GHz SSID:  [Sharing Network](#)

[COPY HOST SSID](#)

Hide SSID broadcast

**Notes:** The extended 2.4GHz password is the same as your Host password.

2. Create a new SSID in [Extended 2.4GHz SSID](#) or click [COPY HOST SSID](#). The value is case-sensitive.
3. Click [SAVE](#).
4. Click [Sharing Network](#) to save the picture of SSID, password and QR code for quickly sharing network.

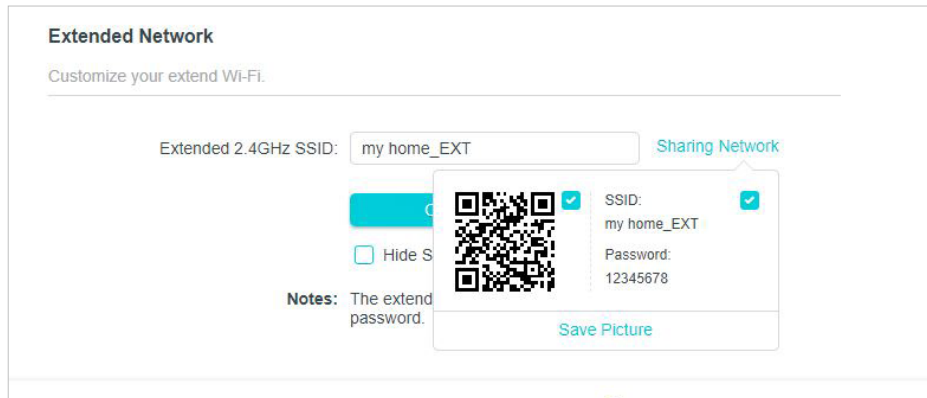

**Note:**

If you have changed the wireless settings via a wireless device, you will be disconnected after the settings are applied. Please write down the new SSID for future use.

- **To hide the SSID of the extended network:**

1. Go to [Wireless](#) and locate the [Extended Network](#) section.

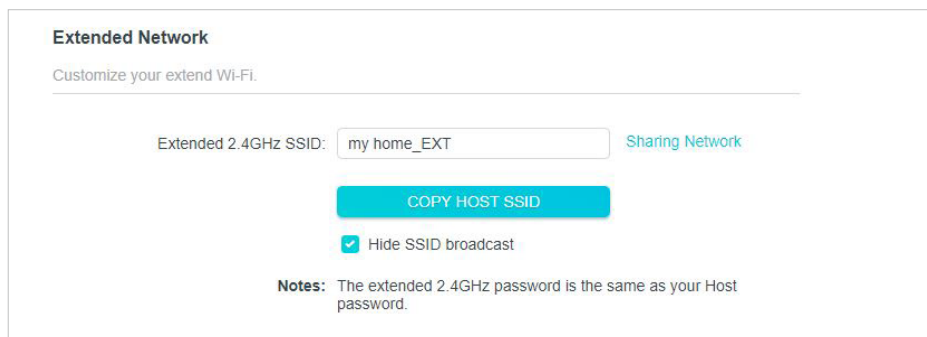

2. Select [Hide SSID broadcast](#), and the corresponding SSID will not be displayed when wireless devices scan for local wireless networks. Devices must join the network manually in order to connect.
3. Click [SAVE](#).

### 3.3. Change LAN Settings

The extender is preset with a default LAN IP 192.168.0.254, with which you can log in to the web management page. The LAN IP address, together with the Subnet Mask, also defines the subnet that the connected devices are on. If the IP address conflicts with

another device on your local network or your network requires a specific IP subnet, you can change it.

1. Visit <http://tplinkrepeater.net>, and log in with the password you set for the extender.
2. Go to **Settings > Network**.
3. Select **Use the following IP address**.

**LAN Settings**  
View and configure LAN settings.

Obtain an IP address automatically  
 Use the following IP address

IP Address:

Subnet Mask:

Gateway:

Primary DNS:

Secondary DNS:  (Optional)

4. Enter a new IP address as needed and leave the **Subnet Mask** as the default settings.
5. Enter the gateway that is in the same subnet as the **IP Address**. The gateway is usually the LAN IP address of your extender.
6. Leave the primary and secondary DNS addresses as the default settings.
7. Click **SAVE**.

### 3. 4. Adjust Wi-Fi Coverage

You can set the extender's Wi-Fi coverage depending on how large you want your Wi-Fi area to be.

1. Visit <http://tplinkrepeater.net>, and log in with the password you set for the extender.
2. Go to **Settings > Advanced Settings > Wi-Fi Coverage**.
3. Select **Maximum Coverage**, **Intermediate Coverage** or **Minimum Coverage** to adjust your Wi-Fi coverage of the extender.

**Wi-Fi Coverage**

Set the Wi-Fi coverage of your extender as needed.

---

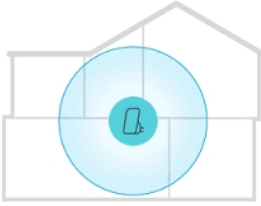

Maximum Coverage  
The extender will provide a long-range Wi-Fi signal but use up more power.

Intermediate Coverage  
The extender will provide a medium-range Wi-Fi signal.

Minimum Coverage  
The extender will provide a short-range Wi-Fi signal and use up less power.

4. Click **SAVE**.

## 3.5. Set Access Control

Access Control allows you to permit or block specific devices from accessing internet for a specific period.

1. Visit <http://tplinkrepeater.net>, and log in with the password you set for the extender.
2. Go to **Settings > Advanced Settings > Access Control**.
3. Enable **Access Control**.

**Access Control**

Control the access to your network from the specified devices.

---

Access Control:

- **To block specific device(s):**

■ **Note:**

Devices connected to the extender via an Ethernet cable cannot be blocked.

1. Select **Blacklist**.

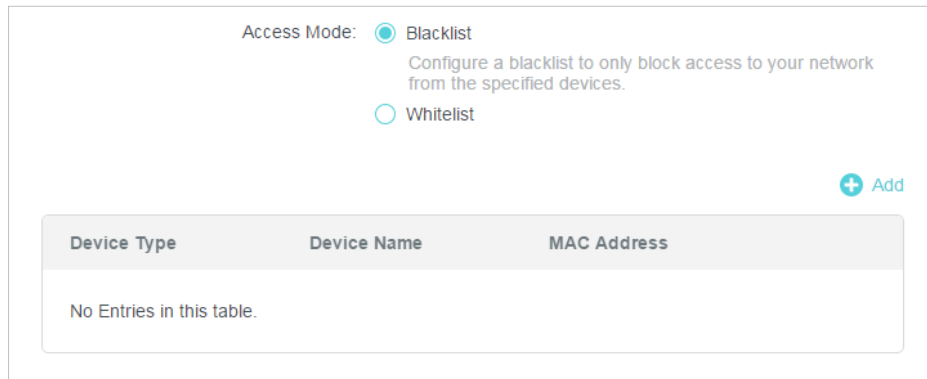

2. Click [Add](#).

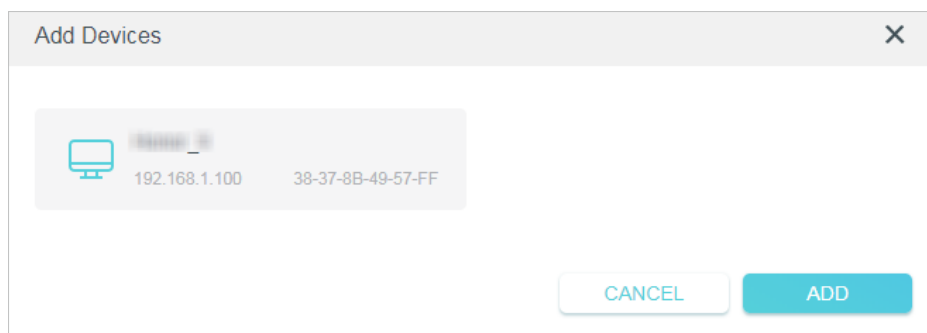

3. Select the device to be blocked in the online devices list and click [ADD](#).

4. Click [SAVE](#).

5. Now the device is added to the blacklist. You can click to remove it from the blacklist.

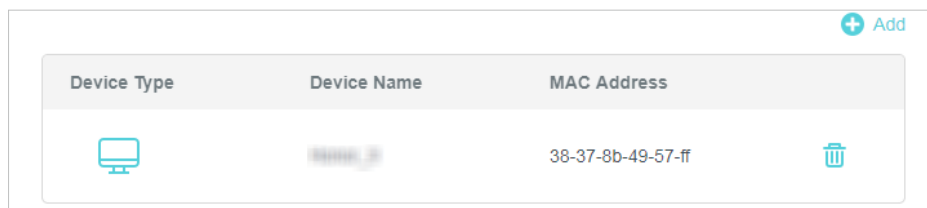

6. Or go to [Network Map](#) and click the icon of [Clients](#) to check the status of connected devices.

- Click [View Blacklist](#) to see the devices in blacklist.
- Click of the corresponding device to add it to the blacklist.



- **To permit specific device(s):**

1. Select [Whitelist](#) and click [SAVE](#).

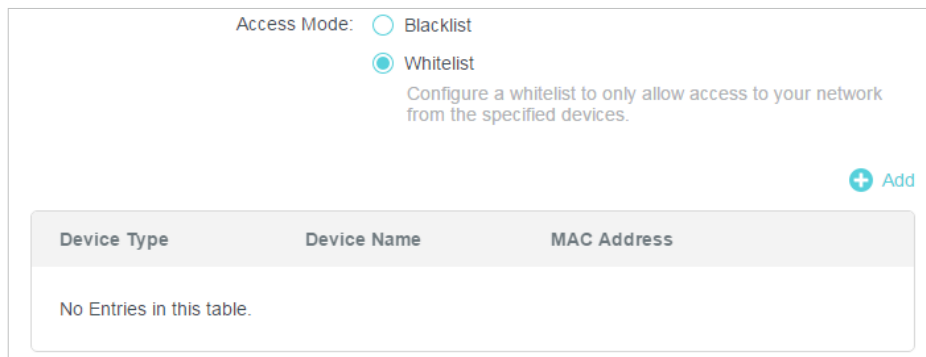

Access Mode:  Blacklist  
 **Whitelist**  
Configure a whitelist to only allow access to your network from the specified devices.

[+ Add](#)

Device Type	Device Name	MAC Address
No Entries in this table.		

2. Click [Add](#).

3. Select the device to be added in the whitelist.

- Select From Device List

Select the device from the device list and click [ADD](#).

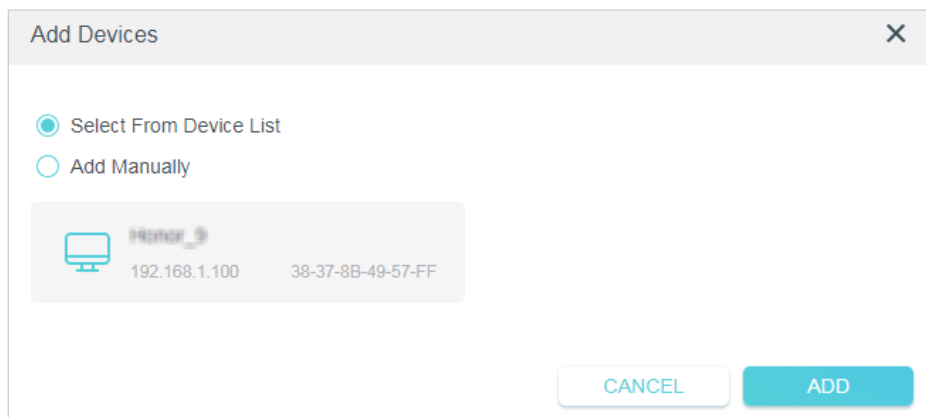

Add Devices ✕

Select From Device List  
 Add Manually

 Honor\_9  
192.168.1.100    38-37-8B-49-57-FF

[CANCEL](#) [ADD](#)

- Add Manually

- 1) Enter the [Device Name](#) and [MAC Address](#) of the device that you want to add to the whitelist.
- 2) Click [ADD](#).

Add Devices
✕

Select From Device List

Add Manually



Device Name:

MAC Address:

CANCEL
ADD

4. Now the device is added to the blacklist. You can click  to remove it from the blacklist.

+ Add

Device Type	Device Name	MAC Address	
	Honor_9	38-37-8b-49-57-ff	

5. Or go to [Network Map](#) and click the icon of [Clients](#) to check the status of connected devices.

- Click [View Whitelist](#) to see the devices in blacklist.
- Click  of the corresponding device to add it to the blacklist.

Connected Clients
View Whitelist

Device Type	Name	IP Address	MAC	Connection Info	Block
	Unknown	192.168.1.200	38-37-8B-49-57-FF	2.4G	



## Chapter 4

---

# More Features of Your Extender

---

This chapter explains how to use the extender as a wireless adapter and as an access point.

It contains the following sections:

- [Use Your Extender as a Wireless Adapter](#)
- [Transform Your Existing Wired Network to a Wireless One](#)

## 4.1. Use Your Extender as a Wireless Adapter

The extender can be used as a wireless adapter to connect any wired-only device, such as a Blu-ray player, game console, DVR, or smart TV, to your wireless network.

After configuration, you can connect an Ethernet-enabled device to the extender via an Ethernet cable.

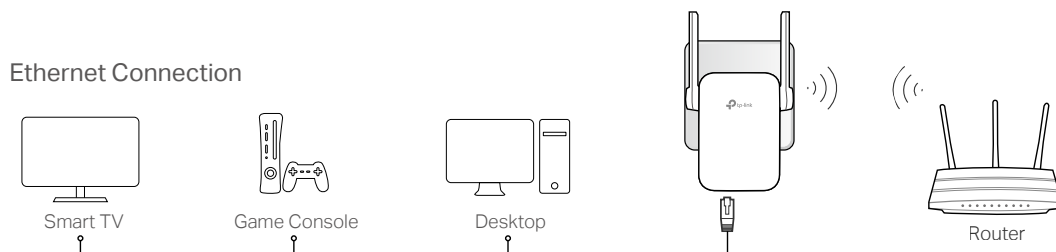

## 4.2. Transform Your Existing Wired Network to a Wireless One

The extender can work as an access point, transforming your existing wired network to a wireless one.

1. Visit <http://tplinkrepeater.net>, and log in with the password you set for the extender.
2. Click **Change Mode** in the top right corner of the page. Select **Access Point Mode** and click **OK**. The extender will reboot and switch to Access Point mode.

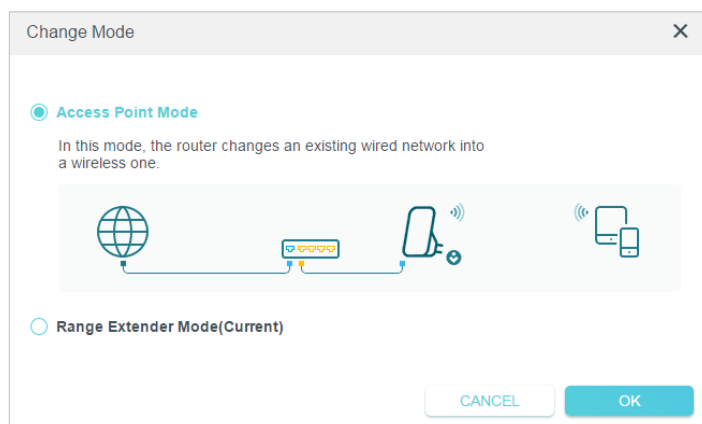

3. After rebooting, connect the extender to your modem or wired router via an Ethernet cable.
4. Visit <http://tplinkrepeater.net>, and log in with the password you set for the extender.
5. Go to **Quick Setup** to configure your extender.
  - 1) Configure your wireless settings and click **NEXT**.

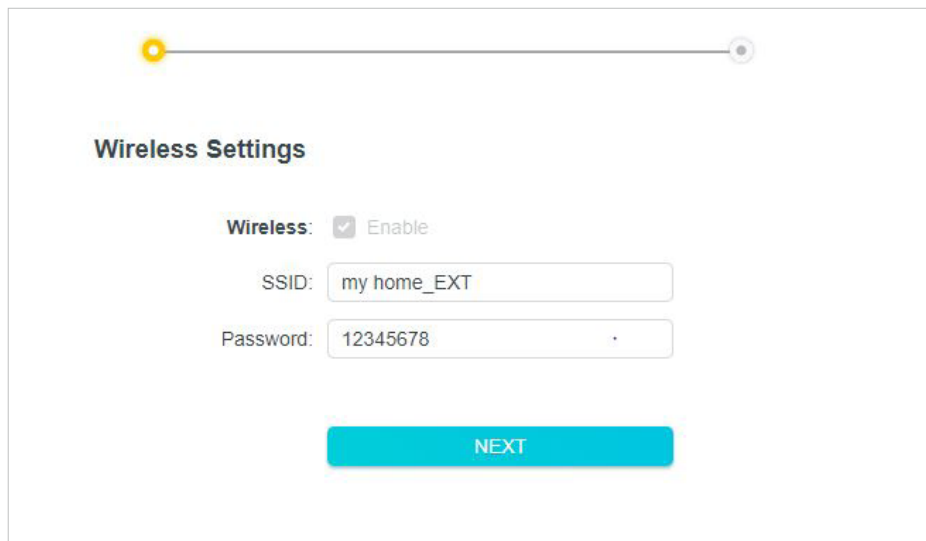

The image shows a 'Wireless Settings' configuration screen. At the top, there is a progress indicator with a yellow dot on the left and a grey dot on the right. Below the title, the 'Wireless' option is checked and labeled 'Enable'. There are two input fields: 'SSID' with the value 'my home\_EXT' and 'Password' with the value '12345678'. A blue 'NEXT' button is centered at the bottom.

- 2) Confirm the information and save the picture for sharing network. Then click **FINISH**. Now, you can enjoy Wi-Fi.

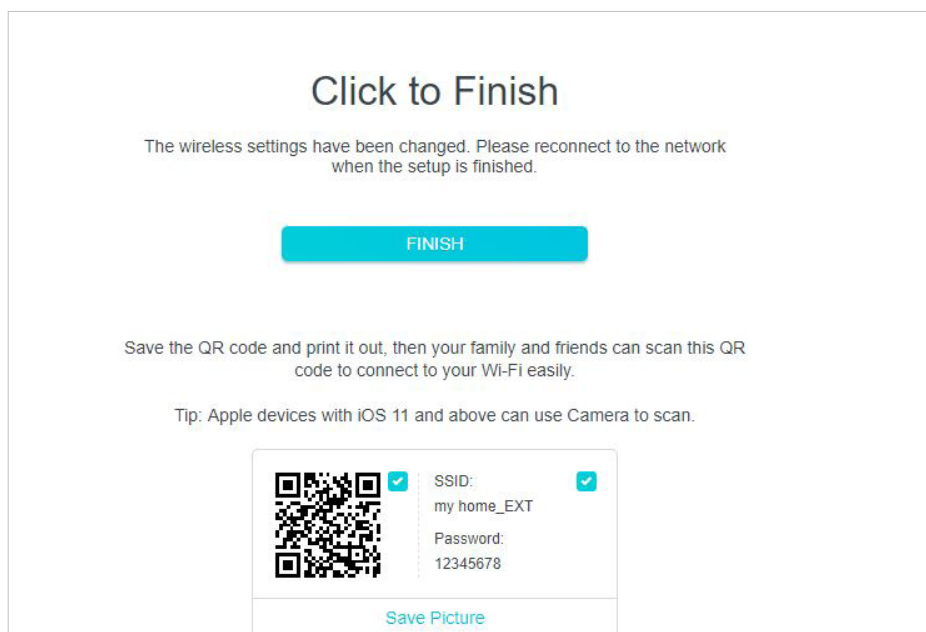

The image shows a 'Click to Finish' screen. The title is 'Click to Finish'. Below it, a message states: 'The wireless settings have been changed. Please reconnect to the network when the setup is finished.' A blue 'FINISH' button is centered. Below the button, a message says: 'Save the QR code and print it out, then your family and friends can scan this QR code to connect to your Wi-Fi easily.' A tip follows: 'Tip: Apple devices with iOS 11 and above can use Camera to scan.' At the bottom, there is a QR code and a summary of the settings: SSID: my home\_EXT and Password: 12345678, both with checkmarks. A 'Save Picture' button is located below the QR code.

## Chapter 5

---

# Manage Your Extender

---

This chapter presents how to manage and maintain your extender.

It includes the following sections:

- [Set Up System Time](#)
- [Control LEDs](#)
- [Power Schedule](#)
- [Upgrade the Firmware](#)
- [Backup and Restore Configuration Settings](#)
- [Reboot Your Extender](#)
- [Change Login Password](#)
- [System Log](#)

## 5.1. Set Up System Time

The System Time of the extender will be used for time-based functions such as the Power Schedule function. If you have enabled the Daylight Saving Time feature, the system time will be synchronized with the daylight saving time you configure.

### 5.1.1. To get system time:

1. Visit <http://tplinkrepeater.net>, and log in with the password you set for the extender.
2. Go to **Settings > System Tools > Time Settings**.
3. Enable **24-Hour Time** or keep it disabled if you don't want the 24-hour system of time reckoning.
4. Select the way to **Set Time**.
  - Get from Internet

**System Time**  
Set the extender's system time.

Current Time: 05/10/2019 15:33:53

24-Hour Time:

Set Time:

Time Zone:

NTP Server I:

NTP Server II:  (Optional)

- 1) Select your local **Time Zone** from the drop-down list.
  - 2) Enter the **NTP Server**.
- Set time manually

**System Time**  
Set the extender's system time.

Current Time: 05/10/2019 16:50:07

24-Hour Time:

Set Time:

Date:

Time:  :  :

- 1) Enter the current time and date.
5. Click **SAVE**.

### 5.1.2. To set up Daylight Saving Time:

1. Visit <http://tplinkrepeater.net>, and log in with the password you set for the extender.
2. Go to [Settings > System Tools > Time Settings](#) and locate the [Daylight Saving Time](#) section.
3. Select [Enable Daylight Saving Time](#).

**Daylight Saving Time**

Automatically synchronize the system time with daylight saving time.

---

Daylight Saving Time:  Enable

Start:2018 Jan First

Sunday 00:00

End:2019 Jan First

Sunday 00:00

Running Status: Daylight Saving Time is on.

4. Select the [Start](#) and [End](#) date and time of the daylight saving time at your local time zone.
5. Click [SAVE](#).

## 5.2. Control LEDs

The LEDs of the extender indicate its activities and status. You can enable the Night Mode feature to specify a time period during which the LEDs are off.

1. Visit <http://tplinkrepeater.net>, and log in with the password you set for the extender.
2. Go to [Settings > Advanced Settings > LED Control](#).

- **To Turn the extender's LEDs on or off:**

1. Locate the [LED Control](#) section, enable or disabled [LED Status](#).

**LED Control**

Turn the extender's LEDs on or off.

---

LED Status:

- **To specify a time period when LEDs are off:**

1. Enable [Night Mode](#).
2. Specify a [LED Off](#) time period, and the LEDs will be off during this period.
3. Click [SAVE](#).

**Night Mode**

Set a time period when the LEDs will be off automatically.

---

**Night Mode:**  Enable

**Note:** Make sure [Time Settings](#) are correct before using this function.

**Current Time:** 05/10/2019 17:15:27

LED Off From:  :

To:  :

**Note:**

The effective LED off time is based on the system time of the router. Please go to [Settings > System Tools > Time Settings](#) to set up the correct time.

## 5.3. Power Schedule

The Power Schedule feature allows you to specify a time period during which the extender is off.

1. Visit <http://tplinkrepeater.net>, and log in with the password you set for the extender.
2. Go to [Settings > Advanced Settings > Power Schedule](#).
3. Click [Add](#).

**Power Schedule**

Schedule when to automatically turn off your extender.

---

**Notes:** Before enabling Power Schedule, please make sure the [Time Settings](#) is correct.

Current Time: 05/10/2019 17:37:20

[+ Add](#)

Power Off Time	Repeat	Status	Modify
No Entries in this table.			

4. Specify a time period in the [Power-Off Time](#) field and days for the power-off to repeat, and the extender will be off during this period in the days you specify.

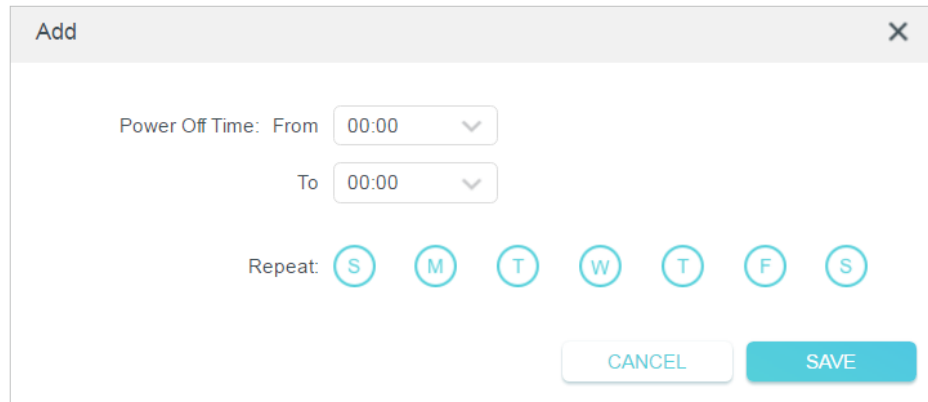

The screenshot shows a dialog box titled "Add" with a close button (X) in the top right corner. Inside the dialog, there are two time selection fields: "Power Off Time: From" and "To", both set to "00:00". Below these is a "Repeat" section with seven circular buttons representing the days of the week: S, M, T, W, T, F, S. At the bottom of the dialog are two buttons: "CANCEL" and "SAVE".

5. Click **SAVE**.

■ **Note:**

The effective power-off time is based on the system time of the router. Please go to [Settings > System Tools > Time Settings](#) to set up the correct time.

## 5.4. Upgrade the Firmware

TP-Link is committed to improving product features, giving you a better network experience. You can download the latest firmware file from the [Support](#) page of our website [www.tp-link.com](http://www.tp-link.com) and upgrade the firmware to the latest version.

■ **Note:**

1. Make sure the latest firmware file is matched with the hardware version (as shown in the download section of the Support page).
2. Make sure that you have a stable connection between the extender and your computer. It is NOT recommended to upgrade the firmware wirelessly.
3. Backup your extender configuration.
4. Do NOT power off the extender during the firmware upgrade.

• **To upgrade the firmware:**

1. Download the latest firmware file for the extender from our website [www.tp-link.com](http://www.tp-link.com).
2. Visit <http://tplinkrepeater.net>, and log in with the password you set for the extender.
3. Go to [Settings > System Tools > Firmware Upgrade](#).
4. Click **BROWSE** to locate the downloaded new firmware file, and then click **UPGRADE**.



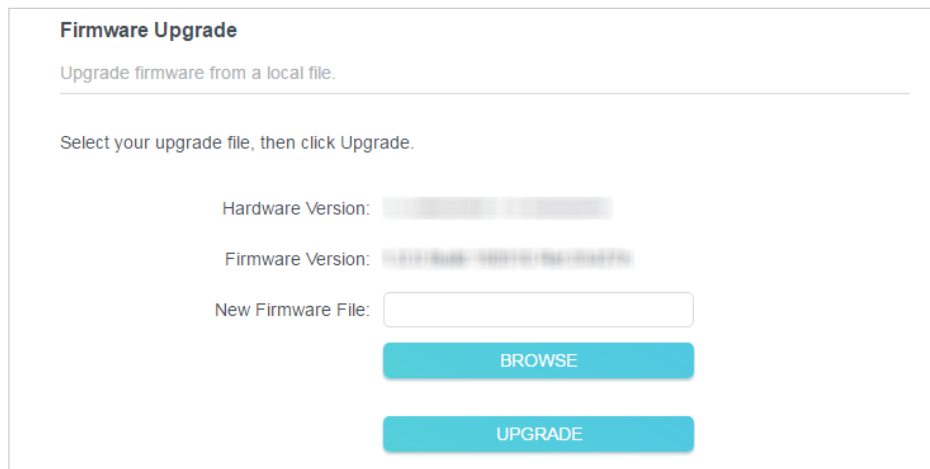

**Firmware Upgrade**

Upgrade firmware from a local file.

---

Select your upgrade file, then click Upgrade.

Hardware Version:

Firmware Version:

New Firmware File:

**BROWSE**

**UPGRADE**

5. Wait a few minutes for the firmware upgrade to complete and the extender to reboot.

## 5.5. Backup and Restore Configuration Settings

The configuration settings are stored as a configuration file in the extender. You can back up the configuration file and restore the extender to the previous settings from the backup file when needed. Moreover, if necessary, you can erase the current settings and reset the extender to the default factory settings.

1. Visit <http://tplinkrepeater.net>, and log in with the password you set for the extender.
2. Go to [Settings > System Tools > Backup & Restore](#).

- **To back up configuration settings:**

Click **BACK UP** to save a copy of the current settings to your local computer. A '.bin' file of the current settings will be stored on your computer.

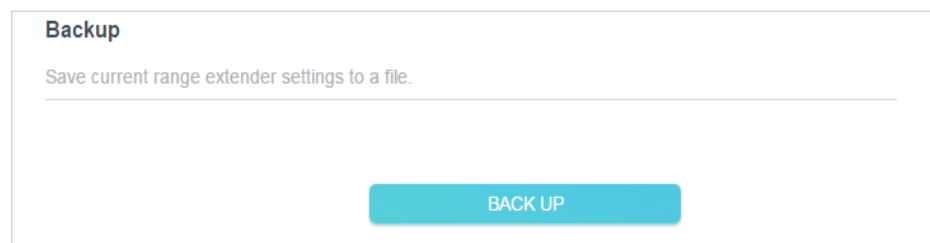

**Backup**

Save current range extender settings to a file.

---

**BACK UP**

- **To restore configuration settings:**

1. Click **BROWSE** to locate the backup configuration file stored on your computer, and click **RESTORE**.

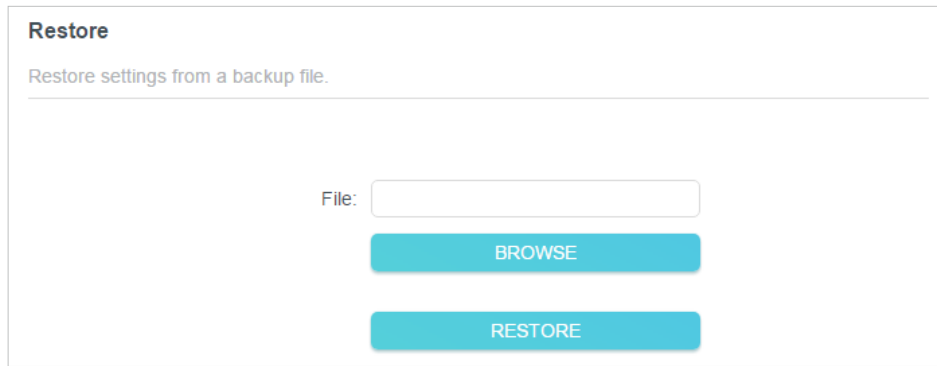

**Restore**

Restore settings from a backup file.

File:

**BROWSE**

**RESTORE**

2. Wait a few minutes for the restore and reboot.

▀ **Note:** During the restore process, do not power off or reset the extender.

- **To reset the extender to factory default settings:**

1. Click **FACTORY RESTORE** to reset the extender.

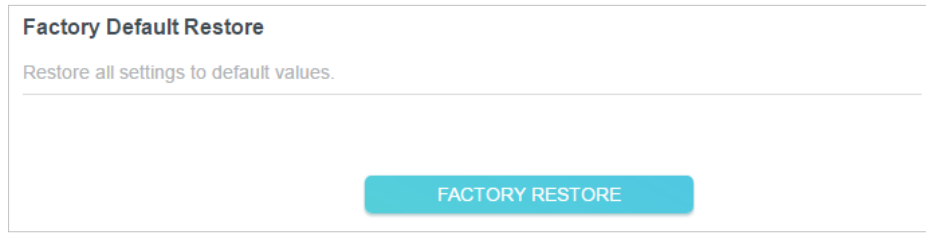

**Factory Default Restore**

Restore all settings to default values.

**FACTORY RESTORE**

2. Wait a few minutes for the reset and reboot.

▀ **Note:**

1. During the reset process, do not power off or reset the extender.
2. We strongly recommend you backup the current configuration settings before resetting the extender.

## 5.6. Reboot Your Extender

The Reboot feature cleans the cache to enhance the running performance of the extender.

1. Visit <http://tplinkrepeater.net>, and log in with the password you set for the extender.
2. Go to **Settings > System Tools > Reboot**.

- **To Reboot Manually**

Locate the **Reboot** section and click **Reboot**.

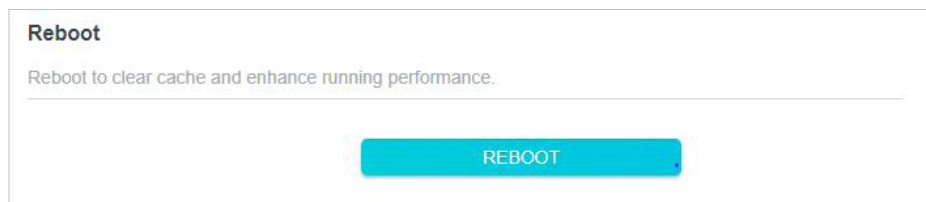

**Reboot**

Reboot to clear cache and enhance running performance.

**REBOOT**

- **To Reboot Automatically**

1. Locate the [Reboot Schedule](#) section and check the box to enable [Reboot Schedule](#).

### Reboot Schedule

Set when and how often the extender reboots automatically.

**Reboot Schedule:**  Enable

**Note:** Make sure [Time Settings](#) are correct before using this function.

**Current Time:** 10/10/2019 00:13:48

Reboot Time: 00 : 00

Repeat: Every Day

2. Specify the [Reboot Time](#) when the router reboots and Repeat to decide how often it reboots.

**Note:**

The effective reboot time is based on the system time of the router. Please go to [Settings > System Tools > Time Settings](#) to set up the correct time.

3. Click [Save](#).

## 5.7. Change Login Password

The account management feature allows you to change your login password of the web management page.

1. Visit <http://tplinkrepeater.net>, and log in with the password you set for the extender.
2. Go to [Settings > System Tools > Change Login Password](#).
3. Enter the old password, then the new password twice (both case-sensitive) and click [SAVE](#).

### Change Login Password

Change the extender's local management password.

Old Password:

New Password:

Confirm New Password:

4. Use the new password for future logins.

## 5.8. System Log

If the extender is not working normally, you can save the system log and send it to our technical support team.

1. Visit <http://tplinkrepeater.net>, and log in with the password you set for the extender.
2. Go to [Settings](#) > [System Tools](#) > [System Log](#).

- **To save the system log locally:**

1. Choose the type and level of the system log as needed.
2. Click **SAVE LOG** to save the system logs to a local disk.

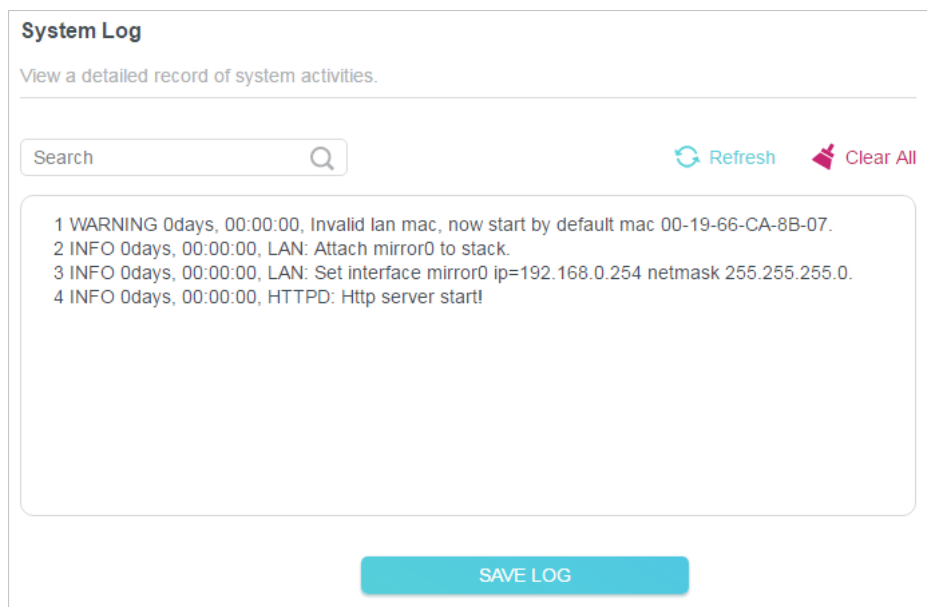

# FAQ

## Q1. How to reset the extender to its factory default settings?

- With the extender powered on, use a pin to press the [RESET](#) button for 1 second. The extender will reboot.
- Log in to the extender's web management page. Go to [Settings](#) > [System Tools](#) > [Restore & Backup](#) and click [Factory Restore](#).

## Q2. What can I do if I forgot my login password?

Refer to [FAQ > Q1](#) to reset the extender, and create a new password for future logins.

**Note:** The extender must be reconfigured after a reset to access internet. Please note down your new login password for future use.

## Q3. What can I do if I forgot my wireless password?

The extender shares the same wireless passwords as those of your host networks.

## Q4. What can I do if I cannot access the web management page?

This can happen for a variety of reasons. Please try the methods below to log in again.

- Make sure your computer is connected to the extended network.
- Make sure your computer is configured as [Obtain an IP address automatically](#) and [Obtain DNS server address automatically](#).
- Use the IP address to access the extender. The default IP is [192.168.0.254](#). If the extender is connected to the router, you should go to your router's DHCP client list to obtain the extender's current IP address.
- Reset the extender. Then connect your computer to its wireless network, enter <http://tplinkrepeater.net> or <http://192.168.0.254> in a web browser and press [Enter](#).

## Q5. I enabled wireless MAC filter, wireless access control, or access control list (ACL) on my router, what should I do to configure and use the extender?

When a device connects through the extender to your router, the MAC address of the device shown on the router is translated to another MAC address. If your router's MAC filter, wireless access control, or ACL is enabled, the devices connected to the extender cannot get an IP address from the extender and cannot access internet.

To solve this problem, please follow the steps below:

1. Log in to your router and disable the MAC filter, wireless access control or ACL.

**Note:** For more information about how to disable your router's MAC filter, wireless access control or ACL, please refer to your router's user guide.

2. Power on your extender, and run the [Quick Setup](#) to configure your extender.

3. Connect all of your devices to the extended network, and make sure the router's Link LED remains lit.
4. On your router, add all the Online Devices' MAC addresses to your router's MAC filter table.
5. Enable the router's MAC filter, wireless access control, or ACL to complete the configuration.

## **COPYRIGHT & TRADEMARKS**

Specifications are subject to change without notice.  tp-link is a registered trademark of TP-Link Technologies Co., Ltd. Other brands and product names are trademarks or registered trademarks of their respective holders.

No part of the specifications may be reproduced in any form or by any means or used to make any derivative such as translation, transformation, or adaptation without permission from TP-Link Technologies Co., Ltd. Copyright © 2020 TP-Link Technologies Co., Ltd. All rights reserved.

## FCC compliance information statement



**Product Name:** 300Mbps Wi-Fi Range Extender

**Model Number:** TL-WA855RE

**Responsible Party:**

TP-Link USA Corporation, d/b/a TP-Link North America, Inc.

Address: 145 South State College Blvd. Suite 400, Brea, CA 92821

Website: <http://www.tp-link.com/us/>

Tel: +1 626 333 0234

Fax: +1 909 527 6803

E-mail: [sales.usa@tp-link.com](mailto:sales.usa@tp-link.com)

This equipment has been tested and found to comply with the limits for a Class B digital device, pursuant to part 15 of the FCC Rules. These limits are designed to provide reasonable protection against harmful interference in a residential installation. This equipment generates, uses and can radiate radio frequency energy and, if not installed and used in accordance with the instructions, may cause harmful interference to radio communications. However, there is no guarantee that interference will not occur in a particular installation. If this equipment does cause harmful interference to radio or television reception, which can be determined by turning the equipment off and on, the user is encouraged to try to correct the interference by one or more of the following measures:

- Reorient or relocate the receiving antenna.
- Increase the separation between the equipment and receiver.
- Connect the equipment into an outlet on a circuit different from that to which the receiver is connected.
- Consult the dealer or an experienced radio/ TV technician for help.

This device complies with part 15 of the FCC Rules. Operation is subject to the following two conditions:

1. This device may not cause harmful interference.
2. This device must accept any interference received, including interference that may cause undesired operation.

Any changes or modifications not expressly approved by the party responsible for compliance could void the user's authority to operate the equipment.

Note: The manufacturer is not responsible for any radio or TV interference caused by unauthorized modifications to this equipment. Such modifications could void the user's authority to operate the equipment.



**FCC RF Radiation Exposure Statement:**

This equipment complies with FCC RF radiation exposure limits set forth for an uncontrolled environment. This device and its antenna must not be co-located or operating in conjunction with any other antenna or transmitter.

"To comply with FCC RF exposure compliance requirements, this grant is applicable to only Mobile Configurations. The antennas used for this transmitter must be installed to provide a separation distance of at least 20 cm from all persons and must not be co-located or operating in conjunction with any other antenna or transmitter."

We, TP-Link USA Corporation, has determined that the equipment shown as above has been shown to comply with the applicable technical standards, FCC part 15. There is no unauthorized change is made in the equipment and the equipment is properly maintained and operated.

Issue Date: 2020-02-20

## CE Mark Warning



This is a class B product. In a domestic environment, this product may cause radio interference, in which case the user may be required to take adequate measures.

## **OPERATING FREQUENCY (the maximum transmitted power)**

2400 MHz -2483.5 MHz (20dBm)

## **EU Declaration of Conformity**

TP-Link hereby declares that the device is in compliance with the essential requirements and other relevant provisions of directives 2014/53/EU, 2009/125/EC, 2011/65/EU and (EU)2015/863.

The original EU declaration of conformity may be found at <https://www.tp-link.com/en/ce>

## **RF Exposure Information**

This device meets the EU requirements (2014/53/EU Article 3.1a) on the limitation of exposure of the general public to electromagnetic fields by way of health protection.

The device complies with RF specifications when the device used at 20 cm from your body.

## **Canadian Compliance Statement**

This device complies with Industry Canada license-exempt RSSs. Operation is subject to the following two conditions:

1. This device may not cause interference, and
2. This device must accept any interference, including interference that may cause undesired operation of the device.

Le présent appareil est conforme aux CNR d'Industrie Canada applicables aux appareils radio exempts de licence. L'exploitation est autorisée aux deux conditions suivantes :

1. l'appareil ne doit pas produire de brouillage;
2. l'utilisateur de l'appareil doit accepter tout brouillage radioélectrique subi, même si le brouillage est susceptible d'en compromettre le fonctionnement.

## **Radiation Exposure Statement:**

This equipment complies with IC radiation exposure limits set forth for an uncontrolled environment. This equipment should be installed and operated with minimum distance 20cm between the radiator & your body.

## Déclaration d'exposition aux radiations:

Cet équipement est conforme aux limites d'exposition aux rayonnements IC établies pour un environnement non contrôlé. Cet équipement doit être installé et utilisé avec un minimum de 20 cm de distance entre la source de rayonnement et votre corps.

## Industry Canada Statement

CAN ICES-3 (B)/NMB-3(B)

## Korea Warning Statements

당해 무선설비는 운용중 전파혼신 가능성이 있음.

## NCC Notice & BSMI Notice

注意!

依據 低功率電波輻射性電機管理辦法

第十二條 經型式認證合格之低功率射頻電機，非經許可，公司、商號或使用者均不得擅自變更頻率、加大功率或變更原設計之特性或功能。

第十四條 低功率射頻電機之使用不得影響飛航安全及干擾合法通行；經發現有干擾現象時，應立即停用，並改善至無干擾時方得繼續使用。前項合法通信，指依電信規定作業之無線電信。低功率射頻電機需忍受合法通信或工業、科學以及醫療用電波輻射性電機設備之干擾。

## 安全諮詢及注意事項

- 請使用原裝電源供應器或只能按照本產品注明的電源類型使用本產品。
- 清潔本產品之前請先拔掉電源線。請勿使用液體、噴霧清潔劑或濕布進行清潔。
- 注意防潮，請勿將水或其他液體潑灑到本產品上。
- 插槽與開口供通風使用，以確保本產品的操作可靠並防止過熱，請勿堵塞或覆蓋開口。
- 請勿將本產品置放於靠近熱源的地方。除非有正常的通風，否則不可放在密閉位置中。
- 不要私自拆開機殼或自行維修，如產品有故障請與原廠或代理商聯繫。

## 限用物質含有情況標示聲明書

產品元件名稱	限用物質及其化學符號					
	鉛 Pb	鎘 Cd	汞 Hg	六價鉻 Cr <sup>+6</sup>	多溴聯苯 PBB	多溴二苯醚 PBDE
PCB	○	○	○	○	○	○
外殼	○	○	○	○	○	○
電源供應板	—	○	○	○	○	○

備考1. "超出0.1 wt %" 及 "超出0.01 wt %" 系指限用物質之百分比含量超出百分比含量基準值。  
 備考2. "○"系指該項限用物質之百分比含量未超出百分比含量基準值。  
 備考3. " — " 系指該項限用物質為排除項目。



Продукт сертифіковано згідно с правилами системи УкрСЕПРО на відповідність вимогам нормативних документів та вимогам, що передбачені чинними законодавчими актами України.







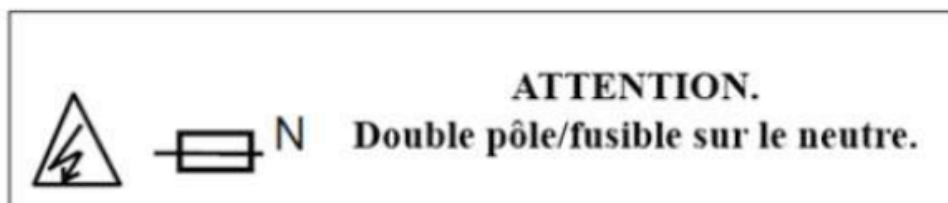
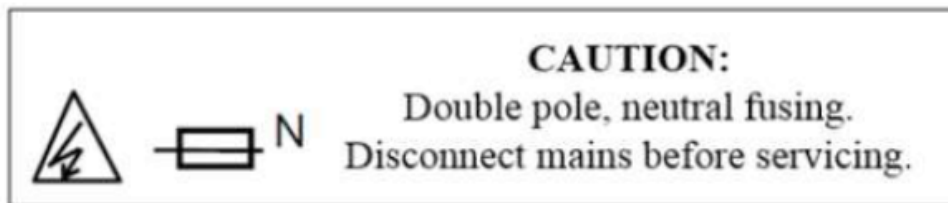

### Safety Information

- Keep the device away from water, fire, humidity or hot environments.
- Do not attempt to disassemble, repair, or modify the device.
- Do not use the device where wireless devices are not allowed.
- The socket-outlet shall be installed near the equipment and shall be easily accessible.

Please read and follow the above safety information when operating the device. We cannot guarantee that no accidents or damage will occur due to improper use of the device. Please use this product with care and operate at your own risk.



## Explanations of the symbols on the product label

Symbol	Explanation
	Class II equipment
	AC voltage
	Indoor use only
	Warning electric shock
	Fuse is used in Neutral N
	<p><b>RECYCLING</b></p> <p>This product bears the selective sorting symbol for Waste electrical and electronic equipment (WEEE). This means that this product must be handled pursuant to European directive 2012/19/EU in order to be recycled or dismantled to minimize its impact on the environment.</p> <p>User has the choice to give his product to a competent recycling organization or to the retailer when he buys a new electrical or electronic equipment.</p>
	Protection earth